



TRI-FUEL/LOW PRESSURE CONVERSION KIT INSTALLATION INSTRUCTIONS

The following instructions give a general outline on installation procedures for adapting gasoline engines to also run on propane and natural gas. These instructions are kept brief for simplicity and we recommend that the installation should be done by a service personnel. Please be aware of the safety regulations as outlined in the National Fire protection Association pamphlets 58, 37 and 5050. There may be additional government recommendations and safety rules in your locality which must be met with those listed above.

*****IMPORTANT*****

Equipment must be installed, operated and maintained in accordance with federal, state and local codes. The installation in most states must also comply with NFPA 54 and NFPA 58 standards. Only personnel trained in the proper procedures, codes, standards and regulations of the LP-Gas industry shall install and service this equipment.

**IF THIS IS NOT POSSIBLE, THE KIT CAN BE RETURNED FOR A FULL REFUND
ADDITIONAL INFORMATION AND INSTRUCTIONS CAN BE
FOUND ON WWW.NASHFUEL.COM**

















REMEMBER SAFETY FIRST!
IF YOU HAVE ANY QUESTIONS, PLEASE CONTACT US FIRST

Phone: 859-881-0509 (call or text)

Email: jerry@nashfuel.com

www.nashfuel.com

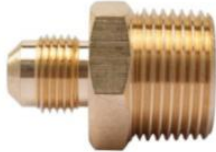
GENERIC PACKING LIST FOR TRI-FUEL ADAPTER

<p>P/N: IMP-039-122 LOCATION: BR1S1B3 QTY: 1</p> 	<p>P/N: SLW25 LOCATION: BR1S2B6 QTY: 2</p> 	<p>P/N: SHCS2508Z5 LOCATION: BR1S2B7 QTY: 2</p> 	<p>P/N: A17032900UX0102 LOCATION: GBS3B11 QTY: 2</p> 
<p>P/N: WTH90006-500R / LP06 LOCATION: HRL7 QTY: 30"</p> 	<p>P/N: ACC3-02 LOCATION: BR1S2B8 QTY: 2</p> 	<p>P/N: 520-02 LOCATION: BR1S2B5 QTY: 1</p> 	<p>P/N: 20031M LOCATION: BR1S2B11 QTY: 1</p> 
<p>P/N: GENERIC LOCATION: SHED QTY: 1</p> 	<p>P/N: SE-5 LOC: BR1S2B9 QTY: 1</p> 	<p>P/N: 1140357 LOC: GBS5B19 QTY: 4</p> 	<p>INSTRUCTIONS</p> 
<p>P/N: BQ-HP08 LOCATION: HRL8 QTY: 36"</p> 	<p>P/N: P41-88 LOC: BR1S2B4 QTY: 2</p> 	<p>P/N: 48-86 LOCATION: BR1S2B4 QTY: 1</p> 	<p>P/N: 48-812 LOCATION: BR1S2B3 QTY: 1</p> 
<p>P/N: ME1654 LOCATION: BR1S2B1 QTY: 1</p> 	<p>P/N: MEGR-230 LOC: BR1S1B4 QTY: 1</p> 		

GENERIC PACKING LIST FOR LOW PRESSURE ADAPTER

<p>P/N: IMP-039-122 LOCATION: BR1S1B3 QTY: 1</p> 	<p>P/N: SLW25 LOCATION: BR1S2B6 QTY: 2</p> 	<p>P/N: SHCS2508Z5 LOCATION: BR1S2B7 QTY: 2</p> 	<p>P/N: A17032900UX0102 LOCATION: GBS3B11 QTY: 2</p> 
<p>P/N: WTH90006-500R / LP06 LOCATION: HRL7 QTY: 30"</p> 	<p>P/N: ACC3-02 LOCATION: BR1S2B8 QTY: 2</p> 	<p>P/N: 520-02 LOCATION: BR1S2B5 QTY: 1</p> 	<p>P/N: 20031M LOCATION: BR1S2B11 QTY: 1</p> 
<p>P/N: GENERIC LOCATION: SHED QTY: 1</p> 	<p>P/N: SE-5 LOC: BR1S2B9 QTY: 1</p> 	<p>P/N: 1140357 LOC: GBS5B19 QTY: 4</p> 	<p>INSTRUCTIONS</p> 

GENERIC PACKING SLIP FOR DFNV KITS. SEE PAGE 8 FOR INSTRUCTIONS

<p>P/N: IMP-039-122 LOCATION: BR1S1B3 QTY: 1</p> 	<p>P/N: SLW25 /SHCS2508Z5 LOC: BR1S2B6 / BR1S2B7 QTY: 2 EACH</p> 	<p>P/N: SHCS2508Z5 LOCATION: BR1S2B7 QTY: 2</p> 	<p>P/N: 20031M LOCATION: BR1S2B11 QTY: 1</p> 
<p>P/N: WTH90006-500R / LP06 LOCATION: HRL7 QTY: 30"</p> 	<p>P/N: ACC3-02 LOCATION: BR1S2B8 QTY: 2</p> 	<p>P/N: 520-02 LOCATION: BR1S2B5 QTY: 1</p> 	<p>P/N: 116-6 QTY: 1 LOC: GBS5B10</p>  <p>P/N: 139-66 QTY: 1 LOC: GBS4B7</p> 

ADAPTER INSTALLATION

All adapter conversion kits use the same basic installation procedure. The venturi adapter will mount between the carburetor and the air cleaner. (see next page for illustration)

1. Remove the air cleaner assembly.
2. Install stud extensions or replace existing studs with longer studs (unless kit provided has barrel nuts, these will install last)
3. Install gasket onto studs against the gasoline carburetor
4. Slide the adapter onto the studs (make note of the flow direction on the adapter)
5. Install vapor hose onto the venturi barb
6. Re-install the air cleaner assembly (if using barrel nuts anchor the airbox back on, use washers between the airbox and barrel nuts if needed for gap)

The venturi adapter will push the air cleaner out on average $\frac{5}{8}$ ". On some engines, the crankcase ventilation hose may be too short. If an extension tube is not included in the kit, you will need to provide your own. This can not be plugged.

Sometimes the frame design on the generator will not allow the air cleaner assembly to be re-installed, in this case the frame will need to be modified. Contact us before frame modification, we may have alternatives. The air flow direction through the venturi is extremely important, the largest cavity should be mounted toward the carburetor. The adapter should have a flow direction on it, if it does and you are unsure, contact us.

REGULATOR INSTALLATION

The demand regulator (KN) can be mounted where convenient within 36" of the venturi adapter in **any position except flat**. A generic bracket has been provided (use tapped ports on bottom) or you can use the tabs on the sides for installation. Make sure the primer button is not compressed with installation.

If you have a tri-fuel conversion kit, a small single stage regulator is included, this is used to bring the tank pressure of a 20lb - 100lb vapor tank down to around 13" wc (0.5psi). A POL connection is included for the tank, works on all vapor tanks and is left hand thread. Install this regulator at the tank and run the supplied line down to the demand regulator.

If you are running natural gas, feed the natural gas directly into the demand regulator, use a ball valve at the connection you are tapping into and shut off when not in use. Minimum inlet pressure is 9"wc and maximum inlet pressure is 13.8"wc, if you are above or below this please contact us.

REMOVE AIRBOX COVER



REMOVE BOLTS HOLDING THE AIRBOX TO THE CARB



SOME AIRBOXES REQUIRE MOUNTING HOLES TO BE DRILLED OUT TO 5/16"



SOME AIRBOXES REQUIRE THE METAL BUSHINGS TO BE REMOVED

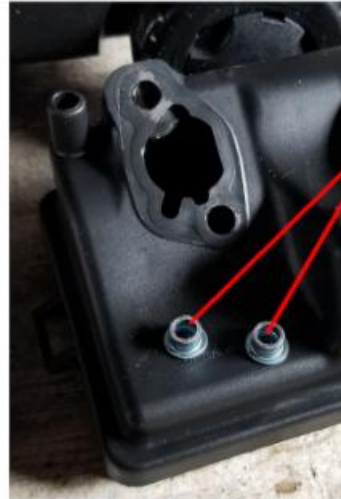

INSTALL VENTURI ADAPTER LARGER BORE AGAINST CARB SMALLER CURVED BORE AGAINST THE AIRBOX



RE-INSTALL AIRBOX USING BARREL NUTS OR EXTENSIONS



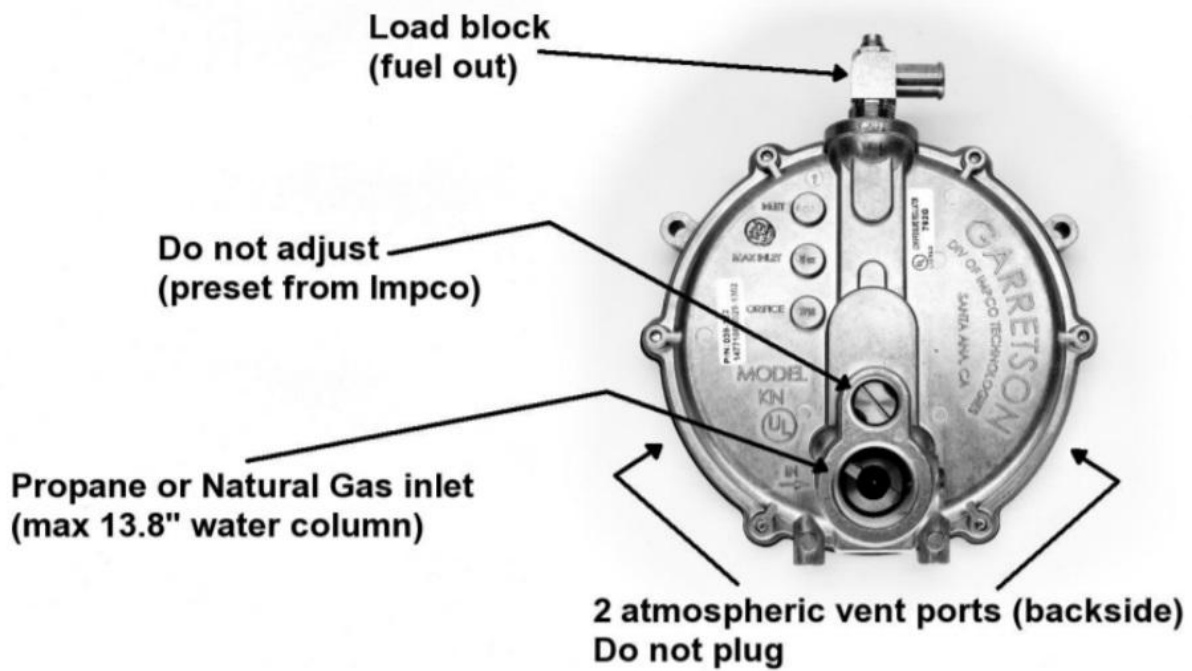
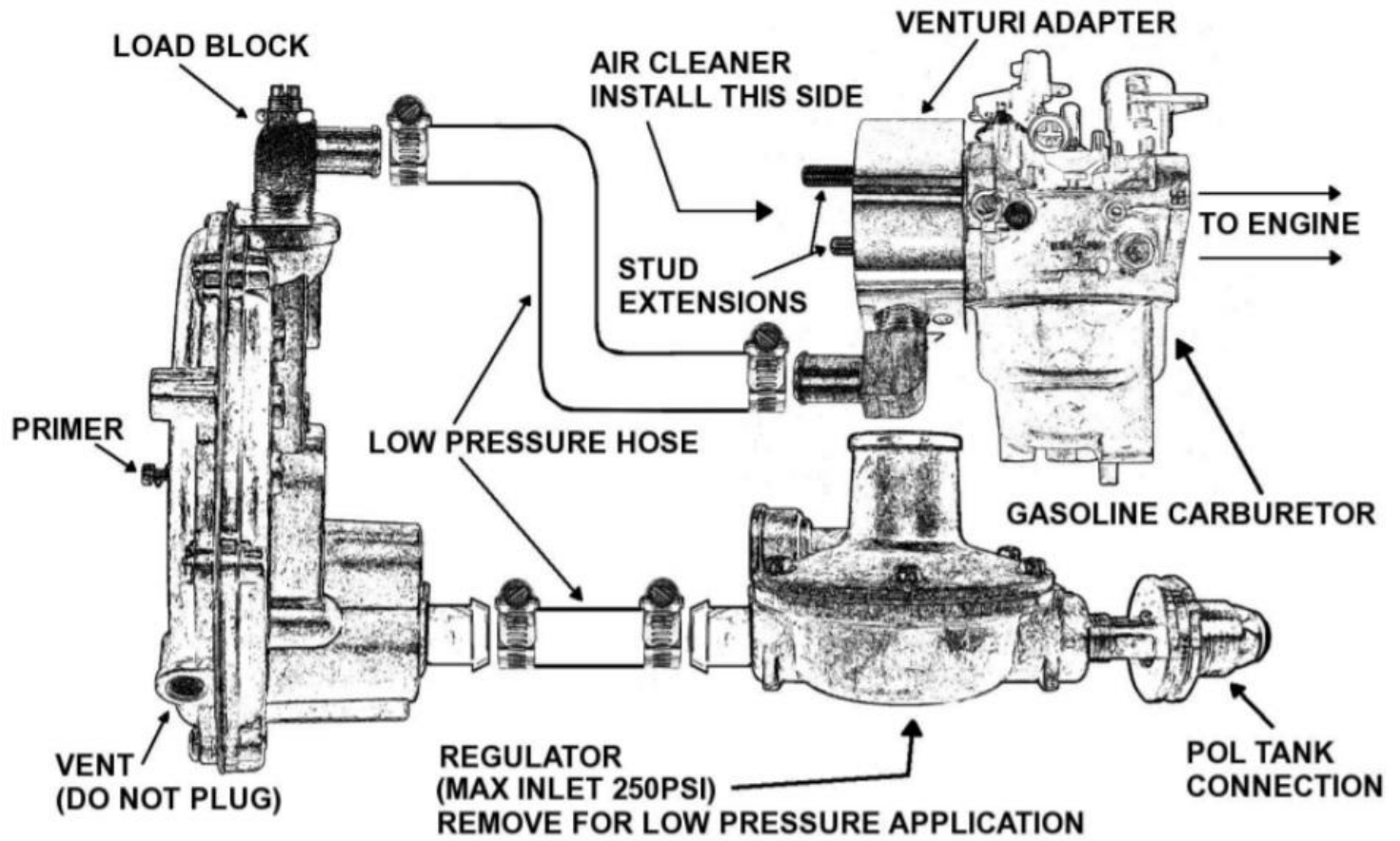

FIRST START INSTRUCTIONS

These are basic first start instructions and are only a basis to work with. Every engine is different and will require specific tuning before the engine runs correctly. If you have any problems, you can contact us for help. **Please make sure all fittings are assembled with the included alternative fuel rated tape and leak tested before continuing.**

1. Make sure the gasoline supply is in the OFF position (or tank is empty) and the engine choke should be in the RUN position for adapter kits, never use the choke with adapter kits. If your engine has an electrical ON/OFF switch, flip it to the ON position.
2. Unscrew the adjustment on the load block completely until it comes out. Re-install 2-3 turns.
3. Turn your alternative fuel supply on and press the primer button for one second or less
4. Attempt to start the engine. If the engine does not start, you may need to adjust the load block in or out and re-prime if necessary (this step may need to be repeated several times to get the engine to run well enough to proceed to the next step
5. Once the engine is running, put a full, or near full load on the engine. Turn the load block clockwise (lean) until the engine begins to lose power, then turn the load block counter-clockwise (rich) to where the engine runs best, lock the jam nut.
6. This next step does not work on all generators. Some units will not operate at idle or with eco mode on.

If the engine has the ability to idle down, let the engine slow down to an idle. Adjust the idle gas needle screw (if possible on the gasoline carburetor) to where the engine runs smooth. To set the proper idle speed, adjust the idle air adjustment on the throttle shaft. Do not attempt to set the idle speed with the gas mixture adjustment.

Following these steps the engine should run well under full load or no load. If you have problems starting or running, the load block may need adjustment.

DUAL FUEL OPERATION

The adapter method normally allows the use of alternative fuels OR gasoline. To run your engine on an alternative fuel, simply turn off the gasoline supply. Most generators will have a valve at the bottom of the gasoline tank. Turn the valve to the off position and run the engine until gasoline in the carburetor is depleted. If the generator does not have this option you will need to install one or empty the tank when switching to alternative fuels. **Some engines do not run well on gasoline after the adapter is installed due to the reduced air flow. Older gasoline carburetors have adjustments to compensate for this, most newer carburetors unfortunately do not. If your carburetor does not have the adjustments and it runs poorly on gasoline, it may be necessary to remove the adapter to run on gasoline.**

THIS PAGE IS FOR NATURAL GAS UPGRADE KITS (DFNV)

CAUTION: Wear approved protective gloves and eye protection. This information is not intended to be a substitute for or to supplement any training in the safe handling and use of propane and related equipment, as required by any applicable law. Only individuals properly trained in the safe handling and use of propane and related equipment should be permitted to do so.

Remove the existing line going into the side of the carburetor. Replace with the line we supply

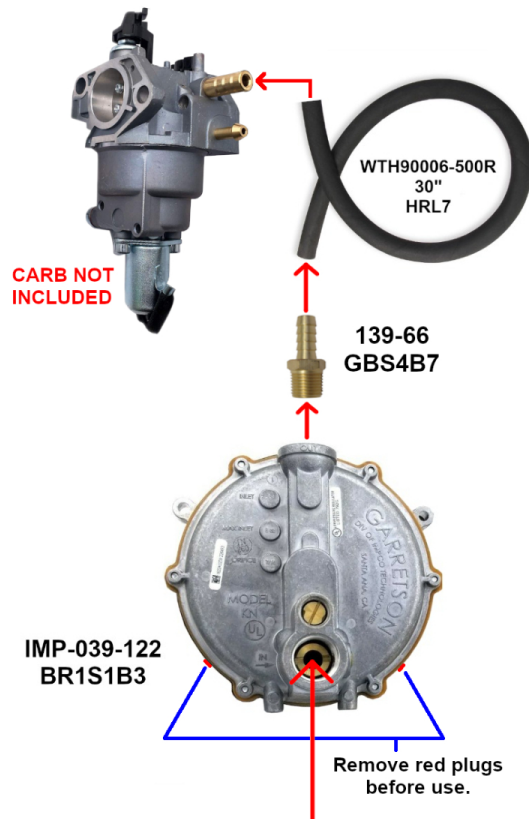

CARB NOT INCLUDED

IMP-039-122
BR1S1B3

Remove red plugs before use.

Propane/Natural gas inlet
 Max inlet 13.8"wc (0.5psi / 8oz)
 To be fed with 3/4" ID line from fuel source (not included)
DOES NOT SUPPORT TANK PRESSURE

- SLW25
BR1S2B6
 - SHCS2508Z5
BR1S2B7
 - IMP-520-02
BR1S2B5
 - C-ACC3-02
BR1S2B8
 - 20031M
BR1S2B11
- Generic mounting bracket with hardware
- Hose clamps to use with WTH90006
- Thread seal, use on all NPT fittings

Very simple installation on these. There is a hose that plugs directly into the side of the carburetor, you will remove that hose. Replace the hose with the one we supply and run that to the demand regulator which we also supply. No tuning is required. Run your natural gas directly into the demand regulator and you are good to go, no permanent modifications required. You can also feed LOW PRESSURE propane into this unit, the propane already regulated down that is fed into a house. Occasionally on natural gas ONLY, a partial choke is required due to natural gas having a rich air/fuel ratio. If you want to use propane directly from a tank, for example a BBQ tank, you would swap back to the original hose and regulator system. The selector switch is too restrictive for natural gas.

PLUG GAP NEEDS TO BE AROUND .025

ADDITIONAL INFORMATION

SAFETY REQUIREMENTS

All fuel control equipment should be installed and maintained per all federal, state, local laws and codes, and NFPA Pamphlet 58 (www.nfpa.org). All of these include a standard, which states for indoor installations, an atmospheric zero governor is not considered a positive shut-off valve and an approved automatic shut-off shall be installed to assure that flow of fuel will be stopped should the engine fail while unattended.

If the inlet pressure is correct, the KN regulator will hold the fuel back until engine vacuum is sensed, then it will deliver fuel upon engine demand. Even though the KN regulator operates in this manner, it still does not qualify as a positive shut-off system for indoor operation.

Our automatic shut-off systems are designed for use with vacuum. Pictured here is an example of a basic vacuum system. Starting the engine will create vacuum, this vacuum will draw on the micro vacuum switch allowing power to be sent to the low pressure 12v lock off. If the engine dies, it will lose vacuum and the micro switch will signal for the lock off to close.

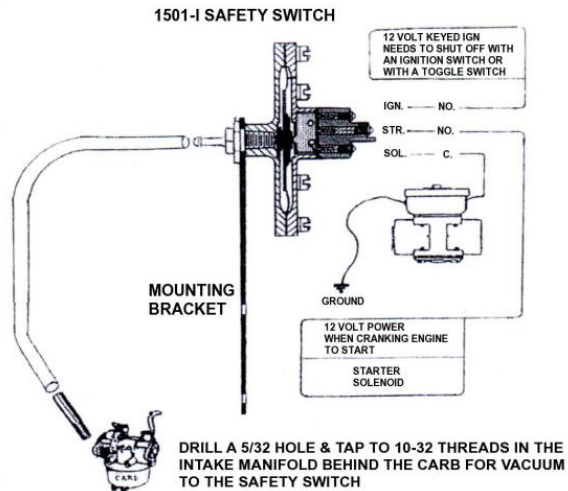

FUEL TYPE

The KN regulator is designed for a maximum inlet pressure of 13.8" water column, and is only compatible with propane or natural gas vapor applications. Tri-fuel conversion kits have an extra regulator to bring high pressure vapor propane down to 12" water column. An air heated regulator is required for liquid applications. Below are a few examples of gaseous fuels.

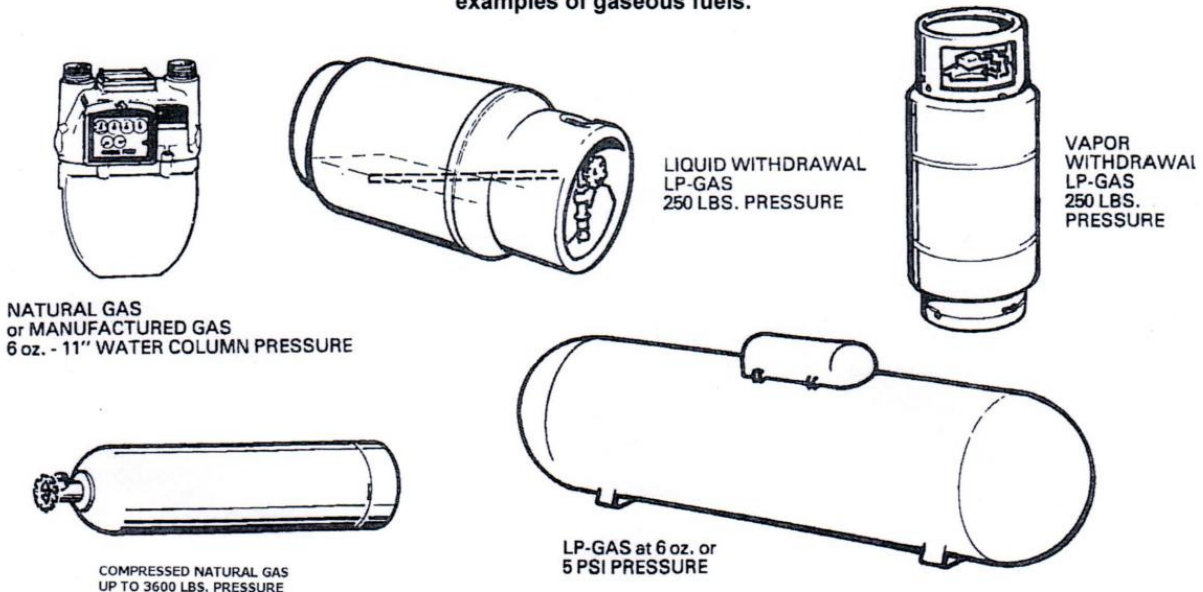

ZERO GOVERNOR REGULATOR MOUNTING

The zero governor should be located according to the recommendations included with it. If this sheet is not available, please follow these suggestions:

The zero governor should be mounted as close to the carburetor as possible with the diaphragm oriented in a vertical plane. This helps to minimize the effects of gravity on diaphragm travel. The unit should also be placed for easy access to the lock-off adjusting screw and primer if provided.

Refer to the piping diagram for the recommended piping system and before installing the fuel supply line, be sure that the gas pressure is no more than the maximum inlet pressure shown on the cover of the zero governor. If the pressure is greater, leakage could result in a fire hazard and / or hard starting.

Flexible piping to the inlet should be used to prevent cracking from vibration if the zero governor is mounted on the engine or other

vibrating surface. Also, piping to the inlet should be of sufficient size to allow full flow to the zero governor. This is very important in natural gas installations as any restrictions smaller than the zero governor orifice can affect engine performance. If a solenoid valve is used ahead of the zero governor in the low pressure line, it should have an orifice at least as big as the orifice in the zero governor.

When an electric solenoid primer is used, follow the wiring and adjusting instructions furnished separately.

Select and install the outlet fitting into the zero governor taking care not to allow any dirt to enter the outlet. Some zero governors may already have a fitting installed at the factory.

After installation of the fuel hose between the zero governor and the carburetor turn on the gas and test the system for leaks at the piping joints using a soap bubble solution or suitable gas detection device.

Important!!!! Mount the regulator in any direction except flat.

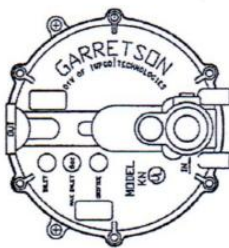

OK

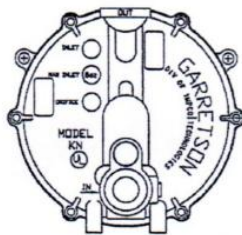

OK

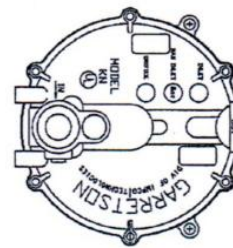

OK

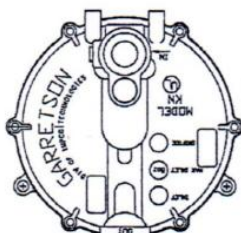

OK

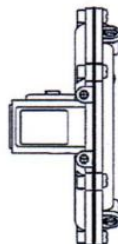

OK

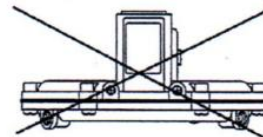

NOT OK

FREQUENTLY ASKED QUESTIONS

I have a vapor withdrawal kit and the engine runs fine for a while and then frost starts to form on one or both of the regulating units. Is it possible the vapor pressure reduction and flow is causing this?

No. Frost is always caused by drawing liquid from the tank. We have had many calls on this over the years and it has always been the same problem. Your tank may be over filled or oriented wrong.

The engine won't start or is hard to start:

More starting problems are caused by over priming or dirt on one of the regulating seats causing gas to leak through. If propane or natural gas make up more than 10% of the fuel-air charge, the spark plug will not ignite the mixture – it is too rich. Propane and natural gas require from 50% to 100% higher temperature to ignite a charge as compared to gasoline. The ignition must be in good shape.

Engine runs but won't come up to full speed or power:

In most cases poor power is caused by a mixture that is too lean. This lean mixture is often caused by too many pressure regulators in the system or a small or restrictive fitting causing poor flow.

Almost all kits are designed so that the engine will lose power if the load adjusting screw is opened too far.

I can get the engine to run at one speed and load okay, but it won't run right if I try to speed it up or slow it down:

This is probably caused by having the idle screw open too far, and the load screw turned in too far. This wrong combination will run the engine at one speed and load. You should close off the idle screw completely, open the main load and get the engine running okay at governed speed. Slowly reduce the speed and as the engine tends to run a little rough, open the idle needle screw just enough to make it run smoothly. Keep working the speed down and keep the idle needle screw adjusted until you reach the desired idle speed.

My engine was idling too fast so I closed down on the idle mixture screw to reduce the speed but it runs rough:

Never attempt to control idle speed with the idle mixtures. Idle speed should be controlled with the idle stop screw near the governor. This adjustment controls the throttle butterfly valve opening at idle and in turn the idle air flow. At that air flow, always set the gas idle mixture screw for fastest speed.

How much fuel will my engine run?

There is a rule of thumb that an engine will consume about 1 gallon of propane per hour for every 10 horse power developed.

Some engine manufacturers recommend that the positive rotators be removed from the exhaust valves when converting to gaseous fuels.

HELPFUL INFORMATION

PRESSURE FACTS	
Simply stated, pressure is the force exerted by a gas or liquid attempting to escape from a container. It is useful to know how strong this "attempt to escape" is. Pressure can be measured with a manometer or with a pressure gauge. At the lower levels, it is expressed in "inches of water column", i.e., 11" W.C. Higher pressure is expressed in terms of the force exerted against a square inch of area. For example, "125 pounds per square inch" (125 psi).	
PRESSURE EQUIVALENTS	
1" Water Column	= .58 oz./sq. in.
11" Water Column	= 6.35 oz./sq. in.
11" Water Column	= .40 lb./sq. in.
1 lb./sq. in.	= 27.71" water column
1 lb./sq. in.	= 2.04" Mercury
1" Mercury	= .49 lb./sq. in.
1 Std. Atmosphere	= 14.73 lb./sq. in.

Technical Data — LP Gas					
Physical Properties at 60° F.	Butane	Propane	Gasoline	Natural Gas*	
Chemical Formula C _n H _(n+2)	C ₄ H ₁₀	C ₃ H ₈	C ₈ H ₁₈ / C ₁₀ H ₂₂	CH ₄	
Normal Atmospheric State	Gas	Gas	Liquid	Gas	
Boiling Point	+32°F.	-44°F.	+97°F. Initial +400° end point.	-259°F.	
Octane Number (research)	94	110 plus	82 to 100	110 plus	
Weight per Gallon (lbs)	4.81	4.24	6.16	2.65	
BTU's per Gallon	102,032	91,547	124,600	63,310	
BTU's per Pound	21,212	21,591	20,227	23,890	
Specific Gravity of Gas. Air = 1 (vapor)	2.04	1.55	4.25	0.554	
Specific Gravity of Liquid Water = 1	0.576	0.508	0.739	0.308	
Range of Flammability* % in air, by volume	1.9 to 8.6	2.4 to 9.6	5 to 15	5 to 15	
Self Ignition Temperature	890°F.	950°F.	860°F.	1300°F.	
Chemically					
Correct	By Weight	15.45	15.66	15.05	16.75
Air Fuel Ratio	By Volume	30.94	23.80	59.50	10.58
BTU's per Cubic Foot		3264	2516	6390	1096
Cubic Feet per Gallon		31.26	36.39	19.50	57.75
Cubic Feet per Pound		6.49	8.58	3.17	23.56

	Vapor Pressure, PSIG														
	Outside Temperature, Degrees Fahrenheit														
	-30	-20	-10	0	10	20	30	40	50	60	70	80	90	100	110
100% Propane	6.8	11.5	17.5	24.5	34	42	53	65	78	93	110	128	150	177	204
70% Propane 30% Butane	--	4.7	9	15	20.5	28	36.5	46	56	68	82	96	114	134	158
50% Propane 50% Butane	--	--	3.5	7.6	12.3	17.8	24.5	32.4	41	50	61	74	88	104	122
70% Butane 30% Propane	--	--	--	2.3	5.9	10.2	15.4	21.5	28.5	36.5	45	54	66	79	93
100% Butane	--	--	--	--	--	--	--	3.1	6.9	11.5	17	23	30	38	47

Pressure Facts - We take advantage of the fact that pressure "attempts to escape," and use it to move gas along the pipe or tubing to the engine. Outside temperature greatly affects container pressure. Too low a container pressure means that not enough gas is able to get to the engine. The table above shows vapor pressures for different gas mixtures at various outside temperatures.

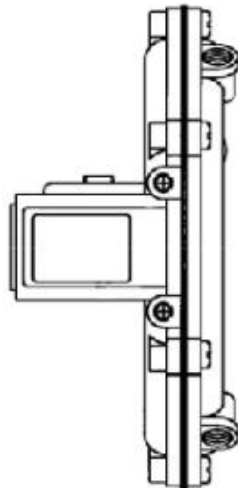
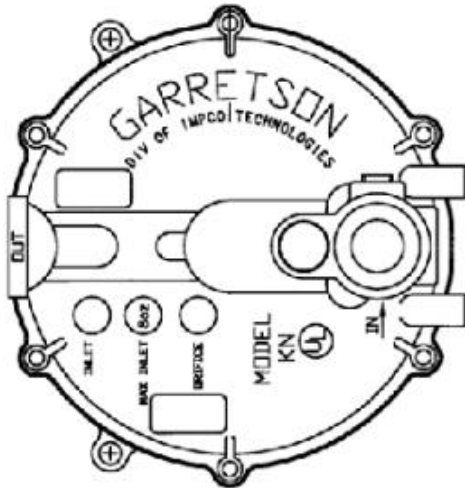

MODEL KN REGULATOR

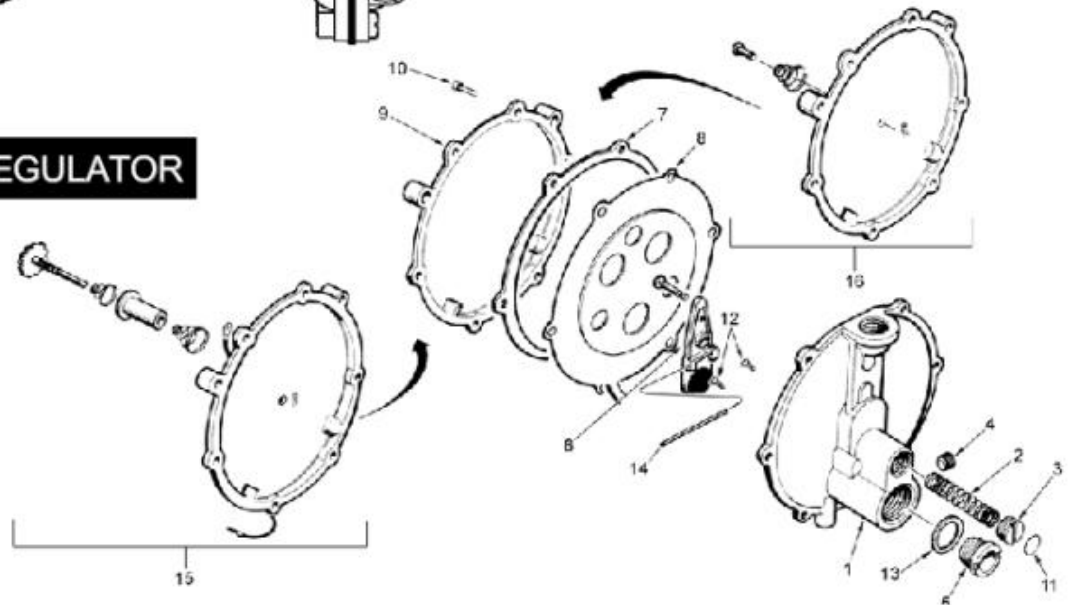

The Model KN is a secondary regulator designed for maximum sensitivity and simple, trouble free operation. It is suitable for use with low pressure, Natural Gas and LPG Vapor fuels. This regulator is typically used in service applications up to 30 kW (40 hp). A new high flow capacity unit is also available with a 1/2" orifice, suited for service applications up to 37 kW (50hp). The KN regulator is completely rebuildable using an IMPCO repair kit.

- Fuel TypeLPG Vapor or Natural Gas Vapor
- Inlet Pressure
 - Maximum.....13.84" w.c. (3.44 kPa)
 - Initial Flow Pressure.....-0.05 to -0.35 w.c.
- Operating Temperature Range-40°F to +250°F (-40°C to +121°C)
- Mounting PositionAs close to the carburetor as possible with the arrow on the back cover pointing up to minimize the effects of gravity on diaphragm travel. Horizontal position can be used when fuel contamination can be controlled with HD-5 or HD-10 specified LPG fuel.
- Diaphragm Material.....Silicone
- Applications.....Stationary
- CertificationUL (AU1502) Inquire for specific ECE approval

ADDITIONAL INFORMATION FOR ALUMINUM ADAPTERS

Basic Installation Instructions

Step 1:
Remove Air Filter



Step 2:
Install Stud Extensions



Step 4:
Re-Install Air Filter

Step 3:
Assemble Venturi
Install Venturi & Gasket





Step 5:
Assemble KN Regulator

Step 6:
Install KN Regulator

Read First Start
Instructions or
continue to next page
for Tri-Fuel





Step 7:
Install Tri-Fuel
Fittings

Step 8:
Install Regulator

Read First Start
Instructions



PROPANE TANKS GENERAL INFORMATION

- Propane tanks can only be safely filled to 80%, the other 20% allows for pressure fluctuation with temperature change
- Propane is always stored under pressure as a liquid and boils at -44°
- Above -44° the upper portion of the tank will be vapor, the lower portion will settle as a liquid
- Tank design determines if the valve draws liquid or vapor
- Tank pressure unregulated will average 30-250psi (dependent on temperature)
- You can not accurately measure how much propane is in a tank by pressure, you have to measure the liquid propane level via float gauge, sonar or by weight.
- Tank orientation is very important for vapor AND liquid tanks

VAPOR TANKS

Vapor tanks are designed to draw the boiling vapor from the surface of liquid in the tank. Vapor tanks will have a 1-5/16" acme or female POL connection. Sizes can range from 1lb to 100lb, bulk tanks that sit outside of a home and will also include RV tanks. **Figure A** shows a common 20lb grill tank. The yellow color represents vapor propane. Appliances, torches, small engines and other applications use vapor propane and will NOT work with liquid propane. **Figure B** shows a 20lb tank that has been set horizontally, you can see that the tank will now draw liquid which is not safe and will not work with vapor applications. **Figure C** shows a purpose built horizontal vapor tank, brackets welded on for horizontal mounting and an internal tube that draws vapor in a horizontal application. **Figure D** shows standard 1lb (disposable) tanks, these also draw vapor. Finally **figure E** shows a bulk tank that would sit outside of a home. These tanks also draw vapor and usually have a regulator under the lid to bring the pressure down before going to the house. Some tanks also have an optional liquid draw valve (tube shown on the left going to the bottom of the tank to draw liquid)

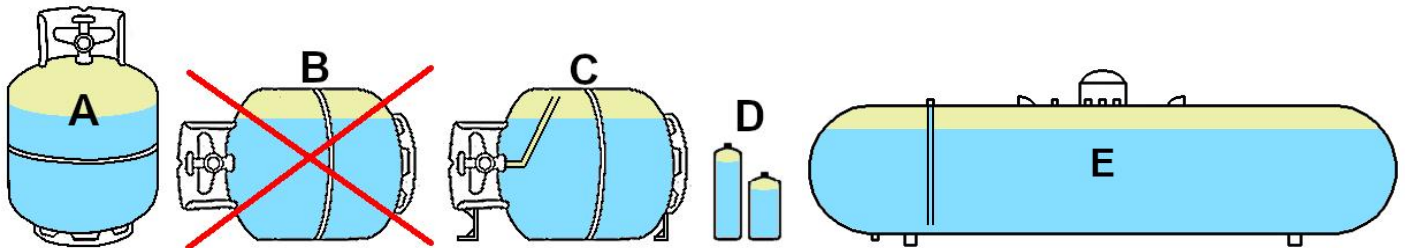

LIQUID TANKS

Liquid tanks are designed to draw liquid propane at all times. Liquid tanks normally have a 1-1/4" acme connection but will sometimes have different connections depending on the application. Liquid tank sizes are commonly 33.5lb and 43.5lb used with forklift and industrial applications but can come in smaller and larger sizes, usually there is a clear marker near the service valve that will say LIQUID. Another example of a liquid draw tank would be an autogas tank found on automotive applications that run on propane. **Figure A** shows a forklift tank standing vertically. The tank has a tube welded internally that goes to the bottom of the tank to draw liquid standing vertically. **Figure B** shows the same tank laying on its side, positioned correctly the tank will still draw liquid.

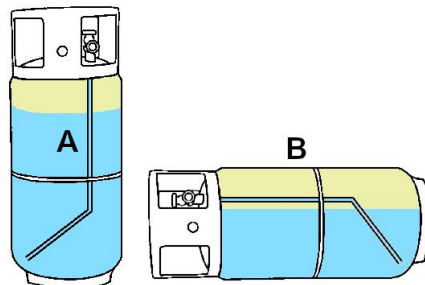

Vaporization Rate - 100 Lb. Propane Cylinders (Approximate)

Lbs. of Propane In Cyl.	Maximum Continuous Draw In BTU Per Hour At Various Temperatures In Degrees F.				
	0°F	20°F	40°F	60°F	70°F
100	113,000	167,000	214,000	277,000	300,000
90	104,000	152,000	200,000	247,000	277,000
80	94,000	137,000	180,000	214,000	236,000
70	83,000	122,000	160,000	199,000	214,000
60	75,000	109,000	140,000	176,000	192,000
50	64,000	94,000	125,000	154,000	167,000
40	55,000	79,000	105,000	131,000	141,000
30	45,000	66,000	85,000	107,000	118,000
20	36,000	51,000	68,000	83,000	92,000
10	28,000	38,000	49,000	60,000	66,000

This chart shows the vaporization rate of containers in terms of the temperature of the liquid and the wet surface area of the container. When the temperature is lower or if the container has less liquid in it, the vaporization rate of the container is a lower value.

The chart below is a reference guide to help determine the correct pipe size if teeing in at the outlet side of the meter. (Note: This is a guide only. Qualified personnel should calculate exact requirements.)

Pipe size (inches) Based on Distance in feet from Meter

Generator Wattage	Engine HP	10	20	30	40	50	60	70	80	90	100	125
1000	2.2	.5	.5	.5	.5	.5	.5	.5	.5	.5	.5	.5
2800 3000	5.5	.5	.5	.5	.5	.5	.5	.5	.5	.75	.75	.75
4000	8.5	.5	.5	.5	.5	.75	.75	.75	.75	.75	.75	1
5200	10	.5	.5	.75	.75	.75	.75	.75	.75	.75	1	1
6600	12	.5	.5	.75	.75	.75	.75	.75	.75	1	1	1.25
12000	22	.75	.75	1	1	1	1	1	1	1	1.25	1.25

Though a generator may need 3/4" or larger pipe to the generator, a 1/2" hook-up hose is usually sufficient if kept short.

TABLE 7 GENERATOR FUEL CONSUMPTION

Generator kW Rating		Fuel Consumption at 100% BTU/HR			Fuel Consumption at 50% BTU/HR		
LP Vapor	Nat. Gas	LP Vapor		Nat. Gas	LP Vapor		Nat. Gas
		BTU/HR	GAL/HR	BTU/HR	BTU/HR	GAL/HR	BTU/HR
7	5	115,000	1.26	117,000	90,000	1	85,000
9	7	125,000	1.37	121,000	79,000	0.87	90,000
11	9	179,000	1.97	159,000	107,000	1.18	111,000
15	13	261,000	2.87	281,000	120,000	1.32	134,000
16	14	267,000	2.94	309,000	229,000	2.52	218,000

Propane

Table 3 – Second Stage or Integral Twin Stage Pipe Sizing

11 Inches Water Column Inlet with a 1/2 Inch Water Column Drop
 Maximum capacity of pipe or tubing in thousands of BTU/hr of LP-Gas

Size of Pipe or Copper Tubing, Inches		Length of Pipe or Tubing, Feet									
		10	20	30	40	50	60	70	80	90	100
Copper Tubing (O.D.)	3/8"	49	34	27	23	20	19	-	16	-	14
	1/2"	110	76	61	52	46	42	38	36	33	32
	5/8"	206	141	114	97	86	78	71	67	62	59
	3/4"	348	239	192	164	146	132	120	113	105	100
	7/8"	536	368	296	253	224	203	185	174	161	154
	1"	291	200	161	137	122	110	102	94	87	84
Pipe Size	3/4"	608	418	336	287	255	231	212	198	185	175
	1"	1146	788	632	541	480	435	400	372	349	330
	1 1/4"	2353	1617	1299	1111	985	892	821	764	717	677
	1 1/2"	3525	2423	1946	1665	1476	1337	1230	1144	1074	1014
	2"	6789	4666	3747	3207	2842	2575	2369	2204	2068	1954

Size of Pipe or Copper Tubing, Inches		Length of Pipe or Tubing, Feet									
		125	150	175	200	225	250	275	300	350	400
Copper Tubing (O.D.)	3/8"	12	11	-	10	-	9	-	8	7	7
	1/2"	28	26	-	22	-	19	-	18	16	15
	5/8"	52	48	-	41	-	36	-	33	30	28
	3/4"	89	80	-	69	-	61	-	55	51	47
	7/8"	137	124	-	106	-	94	-	85	78	73
	1"	74	67	62	58	54	51	48	46	43	40
Pipe Size	3/4"	155	141	129	120	113	107	101	97	89	83
	1"	292	265	244	227	213	201	191	182	167	156
	1 1/4"	600	544	500	465	437	412	392	374	344	320
	1 1/2"	899	815	749	697	654	618	587	560	515	479
	2"	1731	1569	1443	1343	1260	1190	1130	1078	992	923

Natural gas

**Capacity of Schedule 40 Metallic Pipe in Cubic Feet of Natural Gas Per Hour
 (based on .60 specific gravity, 0.30" w.c. pressure drop)**

Pipe Size (Inches)	Length of Pipe in Straight Feet													
	10	20	30	40	50	60	70	80	90	100	125	150	175	200
1/2	131	90	72	62	55	N/A	N/A	N/A	N/A	N/A	N/A	N/A	N/A	N/A
3/4	273	188	151	129	114	104	95	89	83	79	70	63	58	N/A
1	514	353	284	243	215	195	179	167	157	148	131	119	109	102
1 1/4	1,060	726	583	499	442	400	368	343	322	304	269	244	224	209
1 1/2	1,580	1,090	873	747	662	600	552	514	482	455	403	366	336	313
2	3,050	2,090	1,680	1,440	1,280	1,160	1,060	989	928	877	777	704	648	602
2 1/2	4,860	3,340	2,680	2,290	2,030	1,840	1,690	1,580	1,480	1,400	1,240	1,120	1,030	960
3	8,580	5,900	4,740	4,050	3,590	3,260	3,000	2,790	2,610	2,470	2,190	1,980	1,820	1,700
4	17,500	12,000	9,660	8,270	7,330	6,640	6,110	5,680	5,330	5,040	4,460	4,050	3,720	3,460

Right and Wrong Way of Hose Installation



Do not use excessive lengths of hose. Bends below the design bend radii weaken the hose by distorting the wire braid

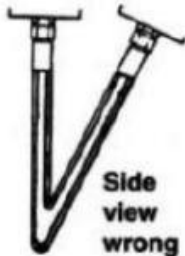
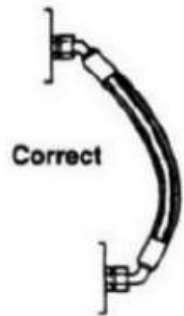

The movement shown in the incorrect side view exerts torsion on the end fittings.

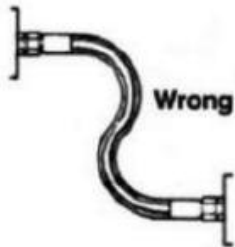
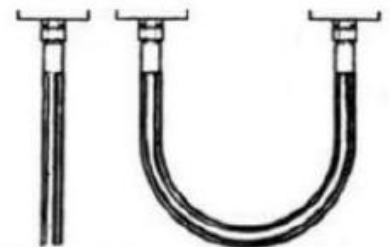

Obtain direct routing of the hose through the use of 90° and 135° Elbow fitting. Improve performance by using less hose and greater bend radius.

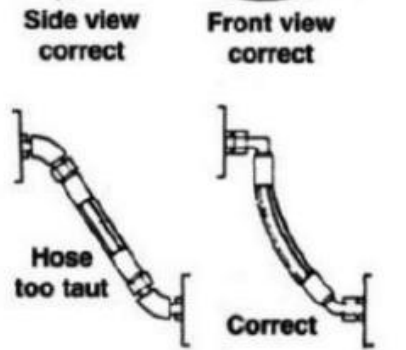

Do not fit hose assembly in twisted condition. This puts tension on the hose and reduces the working life of the assembly. Provide slack or bend in the hose to allow for changes in length that will occur when pressure is applied

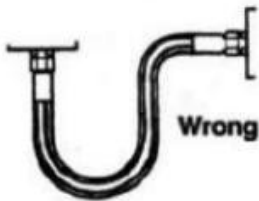
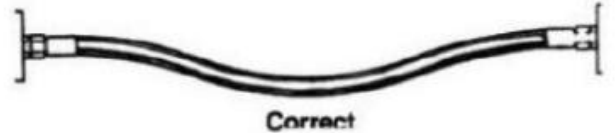
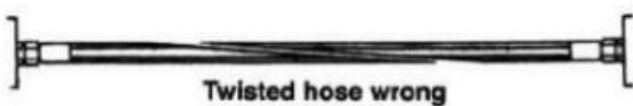

Sharp bends can be avoided by using elbow fittings instead of straights. Avoid the use of bends in hose too close to the fittings.

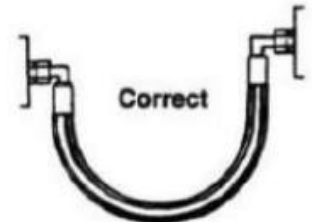

IMPORTANT !

Carbon Monoxide - What service personal should know

OSHA Requirement

The CO level shall NOT EXCEED 50 PPM measured over an 8 hour period in the work environment.

How does parts per million (PPM) relate to percentage numbers?

One million parts per million equals one hundred percent of the engines exhaust gases.

10% CO EQUALS 100,000 PPM

1% CO EQUALS 10,000 PPM

.1% CO EQUALS 1,000 PPM

.01% CO EQUALS 100 PPM

For each one hundredth of one percent you will have 100 PPM

Example: .01% X 1000000 PPM CO = 100 PPM CO.

With adequate ventilation and following the adjustment instructions on page 29 , you should be able to keep the carbon monoxide level below the OSHA requirement.

WE STRONGLY RECOMMEND THE USE OF A CARBON MONOXIDE ANALYZER

INVISIBLE, ODORLESS, DEADLY CARBON MONOXIDE

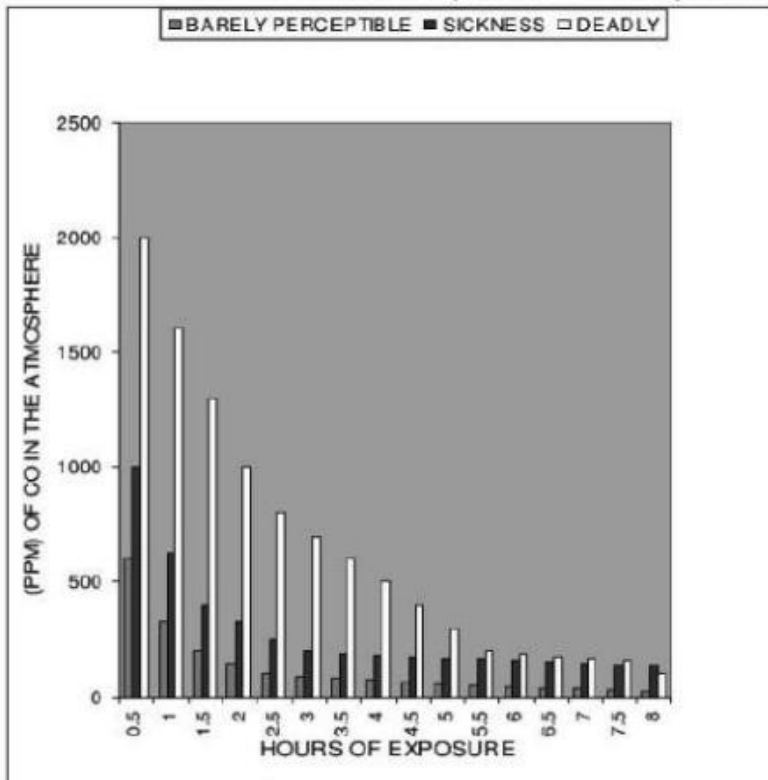

A LITTLE WILL HARM, A LOT WILL KILL

How much is too much? The harmful effects of CO exposure depend on the concentration of the gas in the air, exposure time, and factors such as age, health, size and sex.

Many of us encounter CO regularly and never know it because it's invisible and odorless. That's why victims of CO poisoning often have no warning that they are in danger... until it's too late. Symptoms include headache, nausea, chronic fatigue, confusion and dizziness. Extreme exposure can even cause a coma or death.

HOW CARBON MONOXIDE AFFECTS US

Carbon monoxide is a product of incomplete (poor) combustion. It's a direct and cumulative poison. When combined with blood hemoglobin, CO replaces oxygen in the blood until it completely overcomes the body. Death from CO occurs suddenly. The victim inhaling the toxic concentration of the gas becomes helpless before realizing that danger exists.

HOW MUCH CARBON MONOXIDE IS PERMISSIBLE?

According to the American Society of Heating, Refrigeration and Air Conditioning Engineers (ASHRAE) (Ventilation Standard 62-89), a concentration of no more than 9 parts per million (ppm) (0.0009%), of CO is permissible ventilation air when averaged over 8 hours.

In addition, the Occupational Safety and Health Administration (OSHA) has set an eight-hour work place maximum of 50 ppm. ANSI has established the maximum allowable concentration of CO (when measured on an air free basis) of 400 PPM, for vented gas appliances.

Concentration of CO in air	Inhalation time and toxic symptoms developed
9 ppm (0.0009%)	The maximum allowable concentration for continuous exposure in any 8-hour period, according to federal workplace standards.
50 ppm (0.005%)	The maximum 8 hour average for outdoor air as recommended by US ERA. ASHRAE standard 62-89 states the ventilation air shall meet the outdoor air quality (as standard).
200 ppm* (0.02%)	Slight headache, tiredness, dizziness, nausea after 2-3 hours.
400 ppm (0.04%)	Frontal headaches within 1-2 hours, life-threatening after 3 hours.
800 ppm (0.08%)	Dizziness, nausea and convulsions within 45 minutes. Unconsciousness within 2 hours. Death within 2-3 hours.
1,600 ppm (0.16%)	Headache, dizziness and nausea within 20 minutes. Death within 1 hour.
3,200 ppm (0.32%)	Headache, dizziness and nausea within 5-10 minutes. Death within 30 minutes.
6,400 ppm (0.64%)	Headache, dizziness and nausea within 1-2 minutes. Death within 10-15 minutes.
12,800 ppm (1.28%)	Death within 1-3 minutes.

10,000 PPM (PARTS PER MILLION) = 1% BY VOLUME

All effects can vary significantly based on age, sex, weight, and overall state of health.